



IRON  **WORLD**®

Ornamental Iron

9390 Davis Avenue Laurel MD 20723 Phone: 866-310-2747 Fax: 301-776-7449 www.ironworldfencing.com



Company Overview

Located in Howard County, Maryland, Iron World® is the fastest growing manufacturer and distributor of top-quality ornamental fencing and slide gates in the country. Our world class products meet the highest standards of excellence for design, durability and functionality. You will find our products at such places as the Pentagon, the Washington Monument, the Washington Nationals' Stadium, Norfolk Naval Base, Quantico, New Jersey Devil's Arena, Patriots Stadium and numerous bridges, highways and schools throughout the country.

Our Mission

To provide superior products and services at a competitive price. Iron World® strives to be at the forefront of ornamental fence fabrication and powder coating technology. Customer service is never sacrificed as we service each and every customer as a partner.



Washington Nationals Stadium

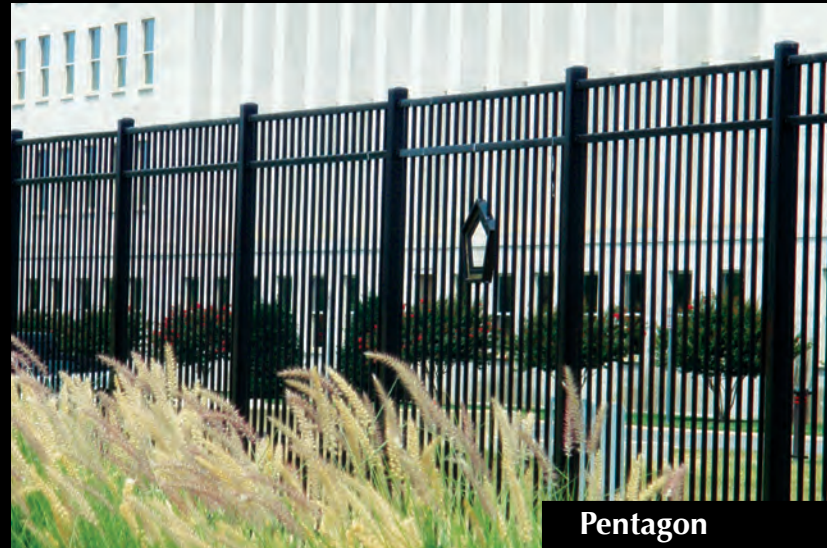

Pentagon

We Stand for Quality

Durable Coating – Iron World® coats their products using a five stage pre-treatment culminating with a non-chromatic conversion coating to seal the surface and provide additional corrosion protection. Fourteen oscillating, automatic spray guns then apply a polyester powder to the G90 galvanized steel to ensure all parts of the products are evenly reached with a 3.0-3.5 mil thickness of coating. Our products are coated pre-assembly to ensure a smooth, consistent finish that resists cracking, flaking and peeling at the panel's



Over 1,000ft in-house powder coating line

pivot points. This process ensures a full measure of protection in the areas where moisture accumulates and rust begins. Our in-house 1,000 foot powder coating line is equipped to handle fencing and gates that are up to 50 feet in length, 8 feet in height and 27 inches in width. Our quality control team ensures the finished product by following our four step quality control process:



Products that are not coated pre-assembly are more likely to rust.

Our Four Step Quality Control Process



1. Visual Inspection



2. Verification of Mil Thickness



3. MEK Rub

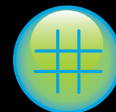

4. Cross Hatch Test to Check for Proper Adhesive

Industrial Aircraft Rivets

To increase panel strength, Industrial Aircraft Rivets, the same product used to build airliners, fasten each picket to the rail giving the system a terrific look with unmatched durability. Fastening each picket to the rails creates an integral structure that provides fixed point loading and spreads any horizontal or vertical force over the entire section. Riveted panels allow damaged pickets to be replaced without scraping the entire panel. Industrial Aircraft Rivets allow you to rack your panels to meet the topography of your job while eliminating the rusting associated with a welded product.

Brackets

Standard Bracket: Iron World™ has transitioned to a tamper proof bolt to add strength, security and ease of installation when fastening your panels to the posts. These brackets come with a top cover to provide a finished look from unsightly rail cuts and short sections. The brackets are open on the bottom to accommodate for installation with uneven grading.



Swivel Bracket: Similar to our standard bracket, the swivel bracket also allows the product to swivel up to 45° left and right. These brackets also use the tamper proof bolt, come with a top cover and are open on the bottom.

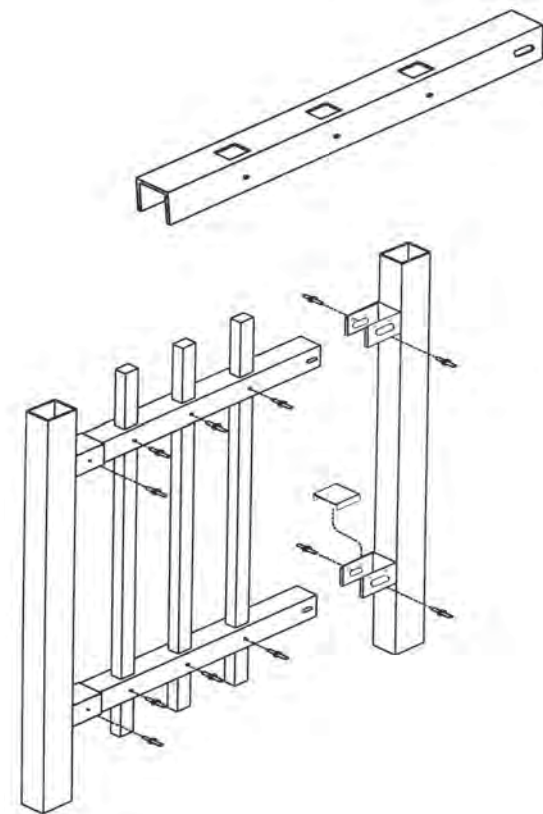
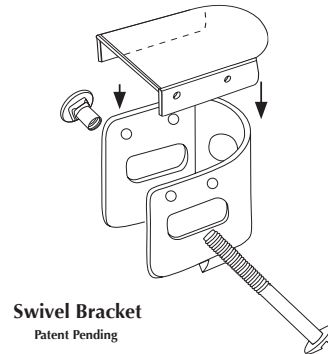
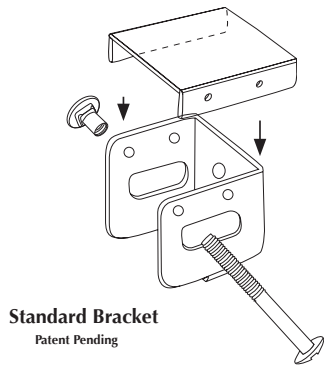

Colors

Iron World™ offers the following standard colors. Unlimited colors available upon request.

White	Brown	Ensor Green
Black	Bronze	Woodland Green

We Focus on Service

Everyone on the Iron World™ staff is focused on providing the highest quality product and service at a competitive price. No hidden charges, price is complete. We give 24 hour quotes! Two Week lead time! Call Toll-Free at 1-866-310-2747 or Fax us at 301-776-7449.

24 Hour Quotes
2 Week Lead Time

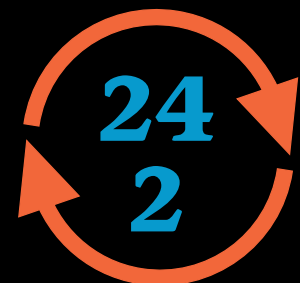

Warranty Information

Iron World™ provides a 20 year warranty on all its ornamental fencing. Our cantilever slide gates come with a 15 year warranty. Please visit our website at www.ironworldfencing.com to print out our warranty information.

Architectural Specifications:

We provide written specification and CAD drawings for each of our product offerings. We also have an architectural team to assist you with getting the information you need to win and complete the job. Visit our website at www.ironworldfencing.com or www.caddetails.com for further information.

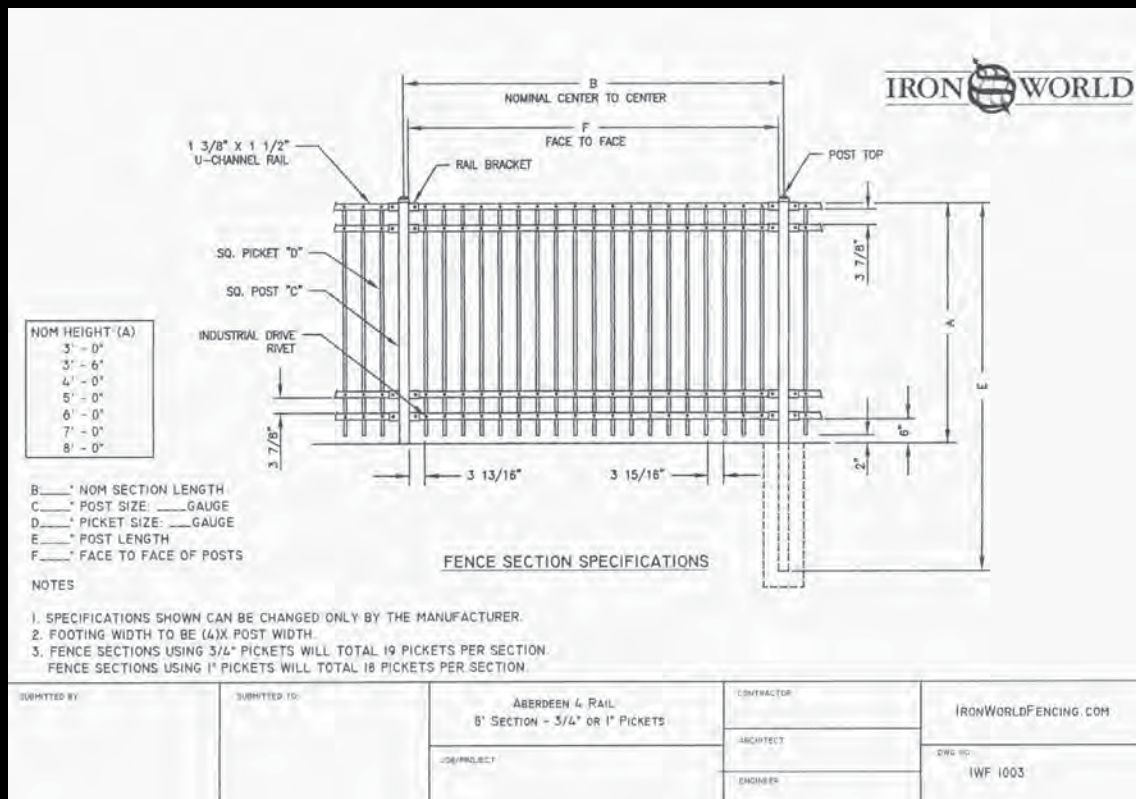

Home About IronWorld Architects Welcome Site Map Contact Us Request a Quote
Phone: 1.866.310.2747

IRON WORLD

Maverick Industrial Solid Iron
Maverick Privacy Panels
Maverick Industrial Iron
Maverick Commercial Iron
Maverick Residential Iron
Swing & Slide Gates
Therma-Fused Polyethylene & Framework
Custom Work
Accessories
Warranty
Gallery
Build Sheets
Specifications
Aluminum Deck Rail
Request a Quote

WELCOME
Located in Howard County, Maryland, Iron World™ is the fastest growing manufacturer and distributor of top-quality ornamental fencing and slide gates in the country. Our world class products meet the highest standards of excellence for design, durability and functionality. You will find our products at such places as the Pentagon, the Washington Monument, the Washington Nationals Stadium, Norfolk Naval Base and numerous bridges, highways and schools throughout the country.

OUR MISSION
Iron World™ strives to be at the forefront of ornamental fence fabrication and powder coating technology. Our mission is to provide superior products and services at a competitive price. Customer service is never farmed out as we service each and every customer as a partner.

FEATURED PROJECTS
Learn how Iron World Inc. improved the fencing around the Washington Nationals baseball stadium. [Read more >>](#)

UPCOMING TRADESHOWS
The 47th Annual American Fence Association's Convention and Trade Exhibition
January 14-16, 2009
New Orleans, LA
Visit Iron World's trade show booth at [Fencecon 2009!](#)

© 2009 Iron World Manufacturing, LLC • 2009 Davis Avenue, Laurel, MD 20723 | Phone: 866-310-2747 | Fax: 301-770-7448

Internet Website:

IronWorldFencing.com enables the user to browse our product offering, submit a quote, find product information and drawings, download architectural specifications and see pictures of recent Iron World™ projects.

MAVERICK™ - S (Solid) Ornamental Panels

The Maverick™ - S (Solid) Line is made with $\frac{3}{4}$ inch solid hot dipped galvanized steel pickets that are then riveted to an 11 gauge channel. Our pickets are hot dipped to provide a protective coating against moisture and rust. This coating is more protective in nature vs. the traditional decorative coating seen on other iron products. Industrial Aircraft Rivets are used to attach each individual picket to the rail allowing the section to rack to your job specifications. These rivets provide the strength of a welded product without the rusting that accompanies them. Individual pickets can be replaced if damage should occur for any reason. The following styles are available in Maverick™ - S:

Aberdeen

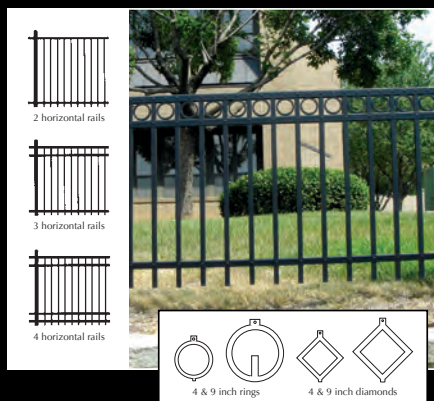

Canterbury

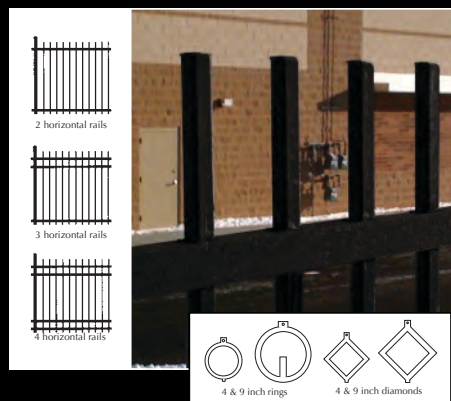

Georgetown

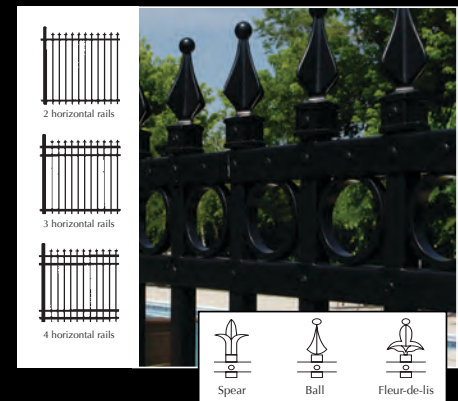

MAVERICK™ - I (Industrial)

The Maverick™ - I (Industrial) is our premier iron product utilizing an 11 gauge channel and both 3/4 and 1 inch steel pickets. These pickets are available in 14 gauge, 16 gauge or 18 gauge steel. Industrial Aircraft Rivets are used to attach each individual picket to the rail allowing the section to rack to your job specifications. These rivets provide the strength of a welded product without the rusting that accompanies them. The Maverick™ - I can rack up to 10 inches on a standard punch channel. The following styles are available in Maverick™ - I:

Aberdeen

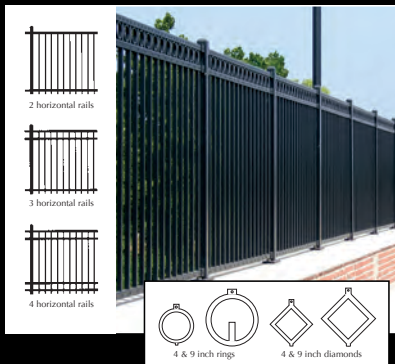

Canterbury

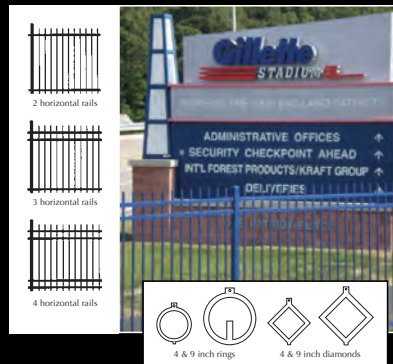

Barcelona

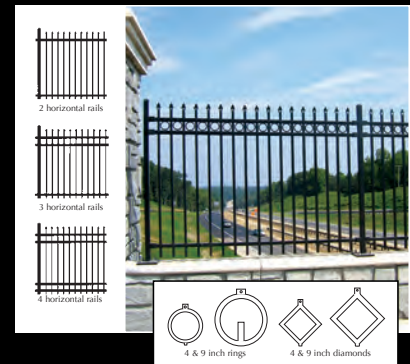

Georgetown

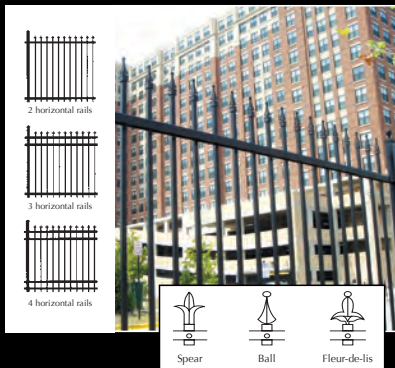

Old Town Series



St. Vincent

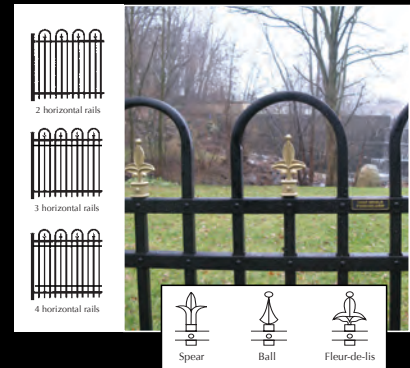

Guardian (17°)

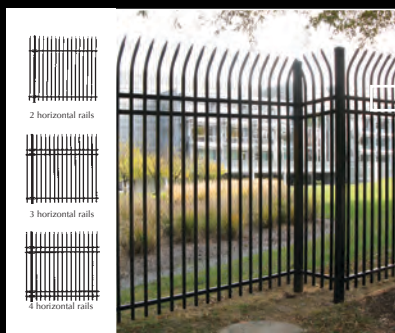

Guardian Plus

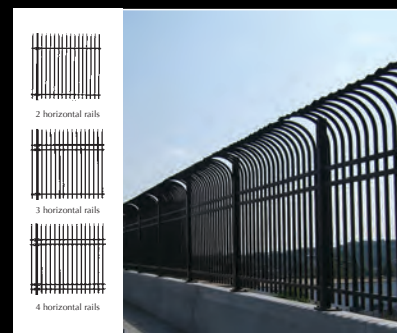

MAVERICK™ - C (Commercial)

The Maverick™ - C (Commercial) is the Maverick™ - I (Industrial) with a 15 gauge channel. The commercial line is available in both 3/4 and 1 inch steel pickets. These pickets are available in 16 gauge and 18 gauge steel. Industrial Aircraft Rivets are used to attach each individual picket to the rail allowing the section to rack to your job specifications. These rivets provide the strength of a welded product without the rusting that accompanies them. The Maverick™ - C can rack up to 24 inches on a standard punch channel. The following styles are available in Maverick™ - C:

Aberdeen

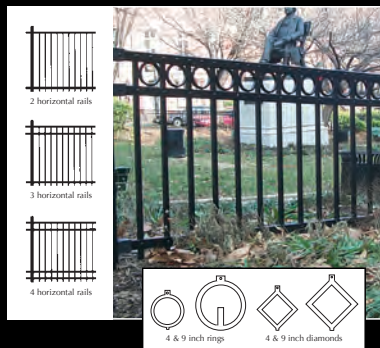

Canterbury

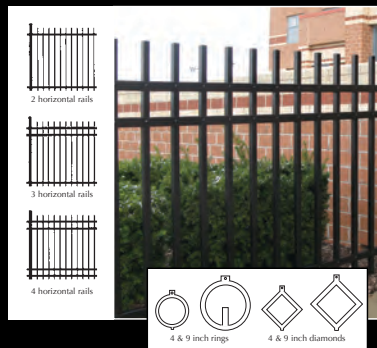

Barcelona

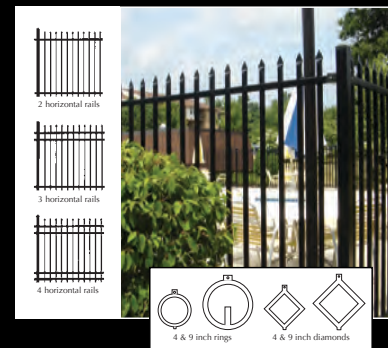

Georgetown

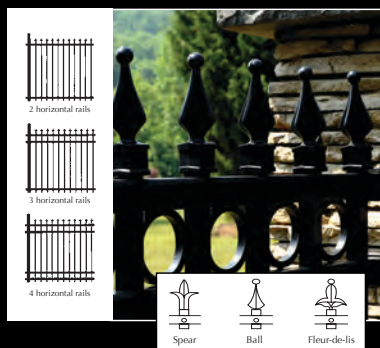

Old Town Series



St. Vincent

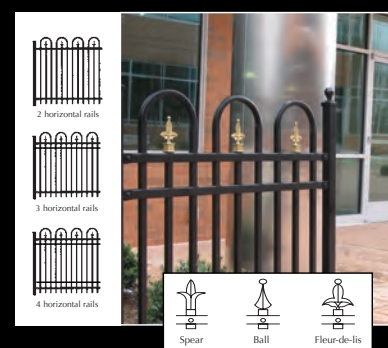

Guardian (17°)

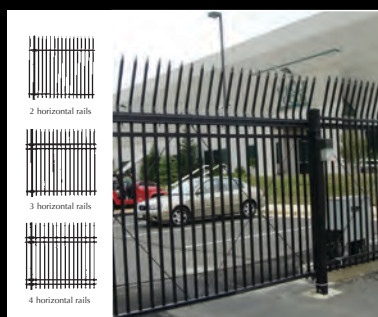

Guardian Plus

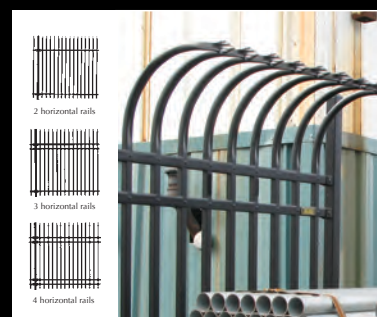

MAVERICK™ - R (Residential)

The Maverick™ - R (Residential) is targeted for residential applications and provides the beauty and security of iron at an affordable price. This product is constructed with a 15 gauge channel and 5/8 inch steel picket. Industrial Aircraft Rivets are used to attach each individual picket to the rail allowing the section to rack to your job specifications. These rivets provide the strength of a welded product without the rusting that accompanies them. The Maverick™ - R can rack up to 24 inches on a standard punch channel. The following styles are available in Maverick™ - R:

Aberdeen

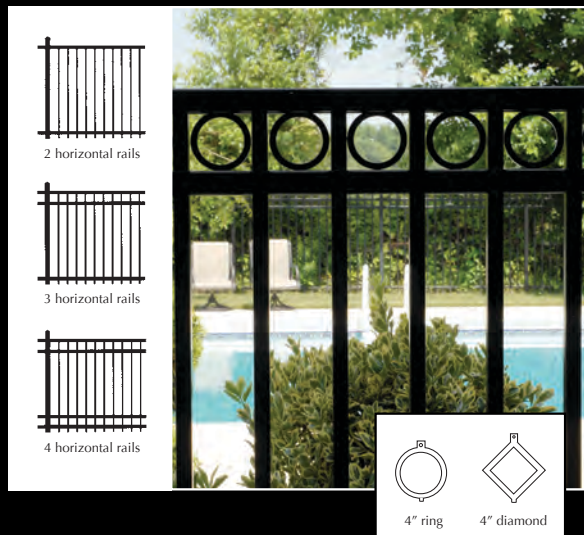

Canterbury

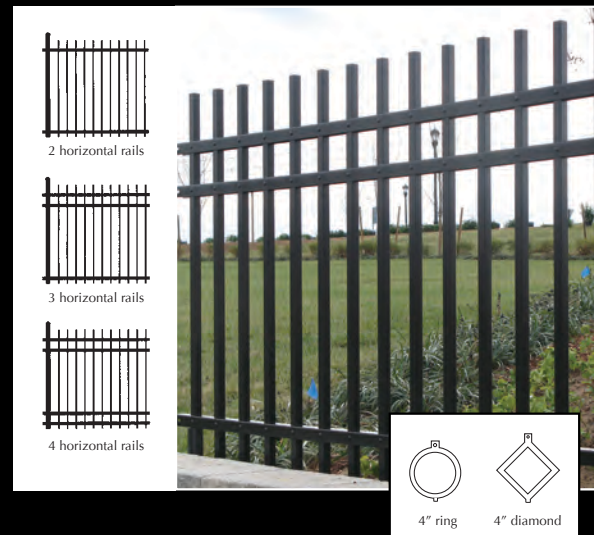

Barcelona

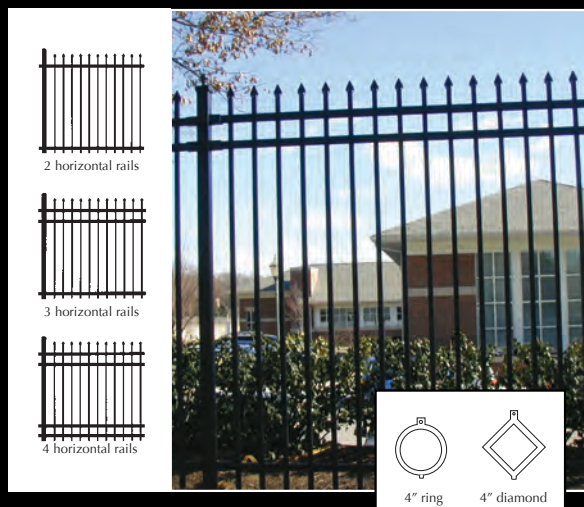

Camden

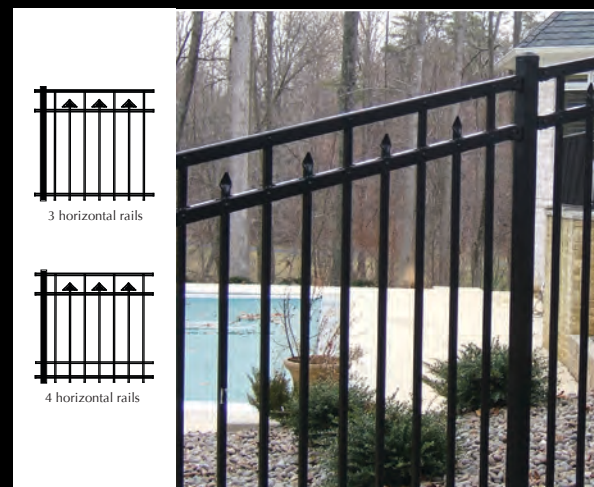

Swing Gates

Iron World™ offers a complete line of swing gates (walk and double drive) that offer privacy and security in a multitude of styles designed to complement any setting and enhance both commercial and residential properties. Iron World™ gates are custom made to precisely fit your opening. They can be built using our residential, industrial or standard commercial materials. Swing gates can range in size from 3 foot single gates to 36 foot double gates. Larger sizes are available upon request. We offer all styles with rings, finials and arches.



Iron World® manufactures gates in all styles with various accessories and picket tops. Over the next few pages we will show you several examples of single and double swing gates. Please reference your specification disk for more ideas or call us to create your customized gates.



Picket Tops

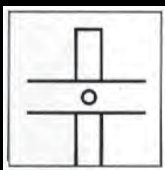

Flat

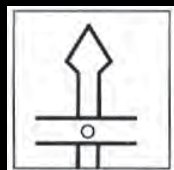

Pointed

Finial Tops

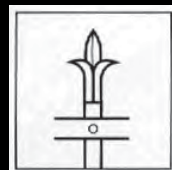

Spear

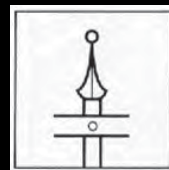

Ball



Fleur-de-lis

Inner Channel Accessories

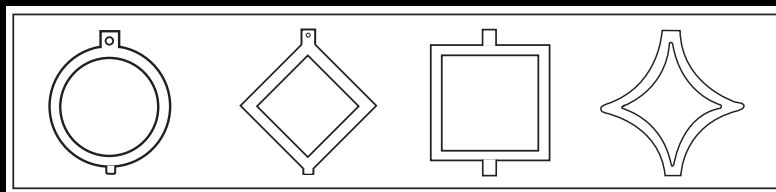

Ring
4" & 9"

Diamond
4" & 9"

Square
6"

Star
4" & 9"

Aberdeen Style Swing Gates



2 horizontal rails



3 horizontal rails



4 horizontal rails

Single Swing



AS-1



AS-2



AS-3



AS-4



AS-5



AS-6

Double Swing



AD-1



AD-2

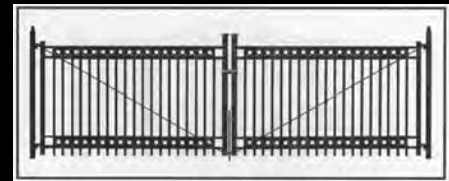

AD-3



AD-4



AD-5

Barcelona Style Swing Gates



2 horizontal rails



3 horizontal rails



4 horizontal rails

Single Swing



BS-1



BS-2



BS-3



BS-4



BS-5



BS-6

Double Swing



BD-1

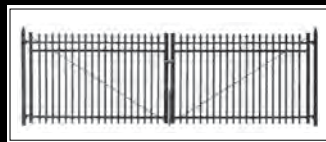

BD-2

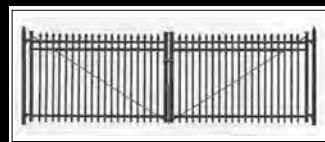

BD-3

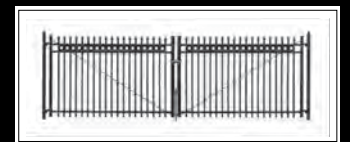

BD-4



BD-5

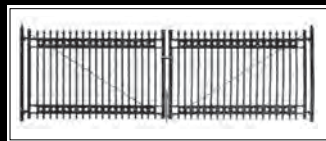

BD-6

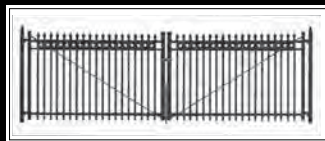

BD-7

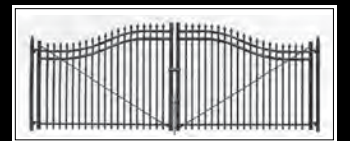

BD-8

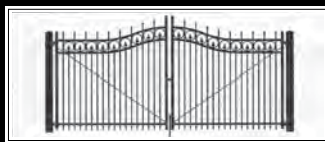

BD-9



BD-10



BD-11

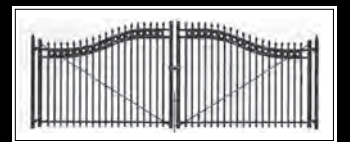

BD-12



BD-13



BD-14



BD-15

Georgetown Style Swing Gates



2 horizontal rails



3 horizontal rails



4 horizontal rails

Single Swing



GS-1



GS-2



GS-3



GS-4



GS-5



GS-6

Double Swing

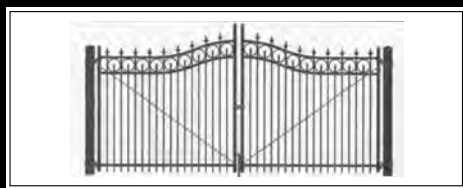

GD-1



GD-2

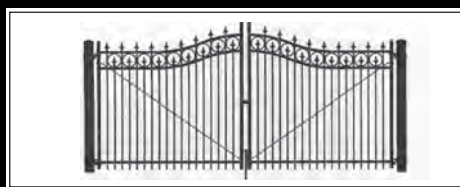

GD-3

Old Town Style Swing Gates



Single Swing



OTS-1



OTS-2



OTS-3



OTS-4



OTS-5



OTS-6



OTS-7



OTS-8



OTS-9



OTS-10

Double Swing



OTD-1



OTD-2



OTD-3



OTD-4



OTD-5



OTD-6

Guardian Style Swing Gates

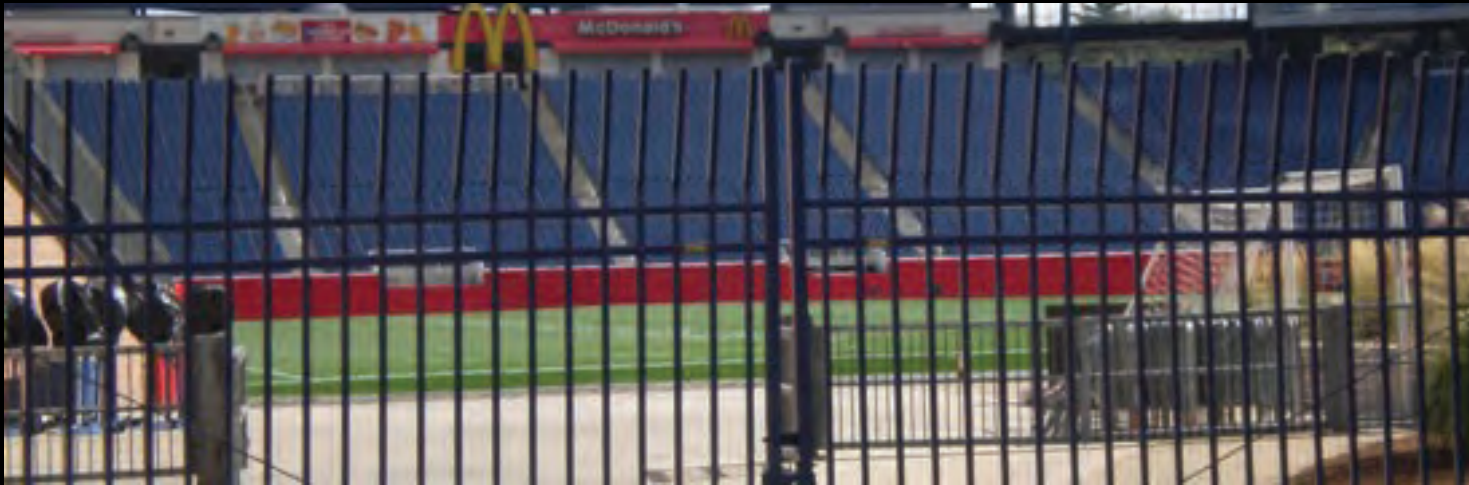

3 horizontal rails



4 horizontal rails

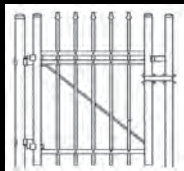

GS-1

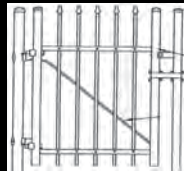

GS-2

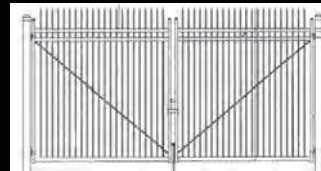

GD-1

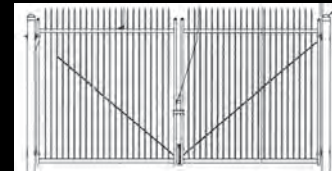

GD-2

Canterbury Style Swing Gates



3 horizontal rails



4 horizontal rails



CD-1

St. Vincent Style Swing Gates



SVS-1



SVS-2



SVD-1

Have You Looked Over the Golden Gate?



Slide Gates

Iron World® prides itself with having the BEST slide gates in the industry. With the Golden Gate Series from Iron World, you will receive the most up-to-date construction features backed by Iron World's quality reputation for craftsmanship, competitive pricing, short lead times and reasonable shipping. Available in an aluminum chain link slider or an ornamental powder coated slider. Features include a closed track system with eight lubricated bearing rollers to protect from the elements and guarantee a smooth opening and closing.



Have You Looked Over the Golden Gate?

The Golden Gate Series

The Golden Gate Series

Features

Lower Roller Guides

- 3/8" solid plate steel
- base/hot dipped galvanized
- 3 1/4" solid rubber wheel w/ball bearing insides

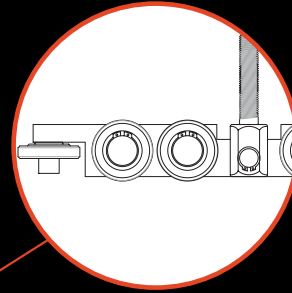
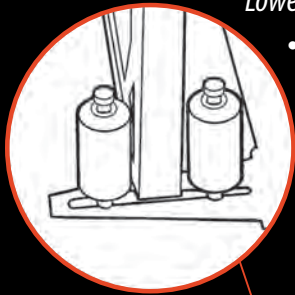

- #### 8 Ball Bearing Rollers
- aluminum shaft
 - two neoprene side rollers

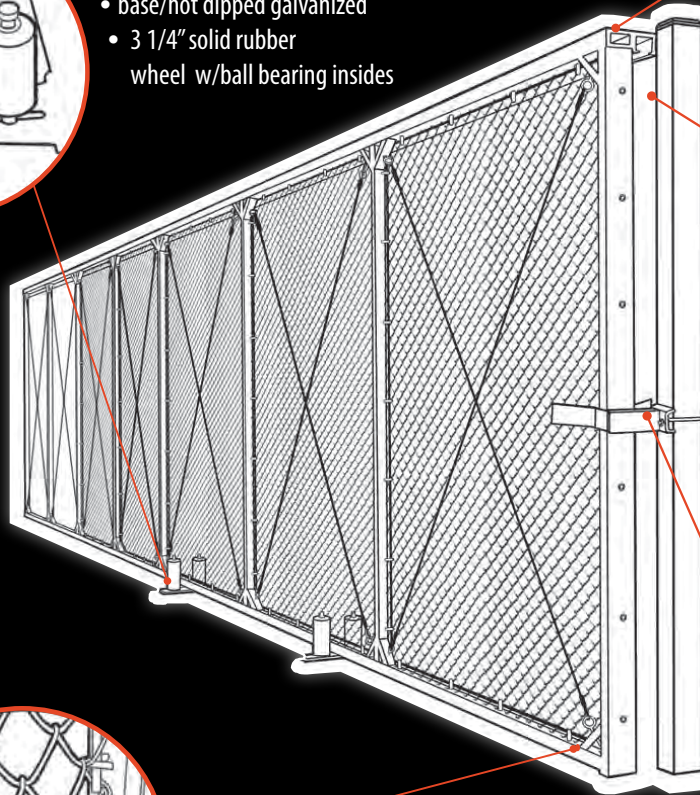

Truck Bracket

- 3/8" hot dipped galvanized
- 5/8" hole to accept 8" bearing truck assembly

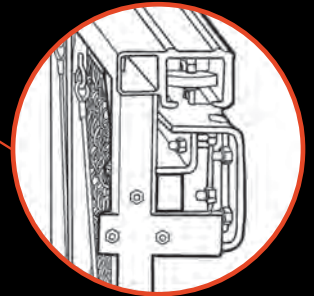

2 x 5 Gate Stop

- hot dipped galvanized
- put at front and back
- ensures gate does not come off rollers



1" Square Gussets

- 5" big eyebolts
- regulate forces of gate as it opens and closes
- will let you make easy adjustments w/nut under gusset
- 1/4" galvanized aircraft cable throughout gate to ensure stability and allows for adjustment



Heavy Duty Gate Receiver

- hot dipped galvanized gate receiver
- guides gate to locking device for secure closure

Have You Looked Over the Golden Gate?



The Golden Gate Series

Specifications

- Available in aluminum chain link, coated chain link or ornamental powder coated slider
- Features a closed track system with eight lubricated bearing rollers to protect from the elements and guarantees a smooth opening and closing
- Made from T-6063 aluminum and wired in aluminized fabric or picketed for ornamental projects
- Backed with a 15 year warranty (see warranty for details)
- Custom made to fit your needs: arches, rings, finials, etc.
- Made with safety in mind – Automated gate package which meets UL 325 code available upon request
- Comes with welded gussets and 1/4 aircraft cables for easy adjustment to guarantee smooth operation



Ornamental Slide Gates

Nothing completes a project better than an ornamental slide gate. Not only do you get the beauty of a completed perimeter of ornamental fencing, but you get the added security without having to use barbed wire. Iron World™ fabricates all gates to customer's exact specifications, from the smallest walkways to 65' box frame gates. No gate is too big or too small for Iron World™.

Available in All Styles

- Barcelona
- Canterbury
- Aberdeen
- Guardian
- Guardian Plus

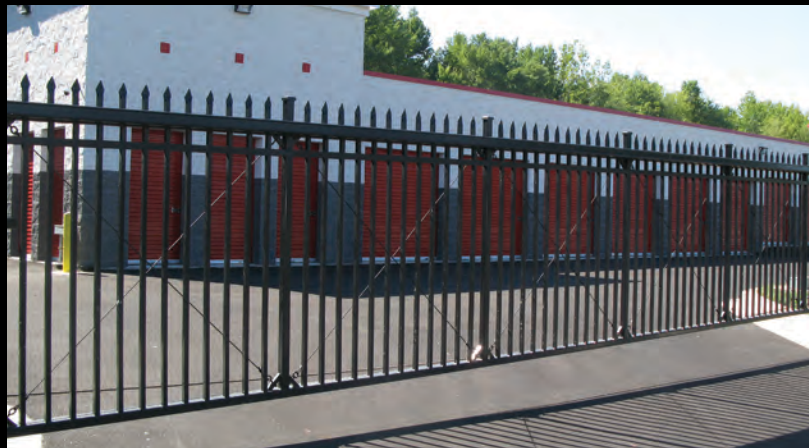

Built to Custom Specifications

- Arches Available
- Dual Track Gates
- Box Frame Gates
- Color Matching Available

Chain Link Slide Gates

Iron World's chain link "Golden Gates" are second to none in the industry. Only the highest quality materials, such as 8-wheel roller and aircraft cables are used in the fabrication of our sliders. We guarantee our gates will protect your entranceway for years to come. Our gates work great with operators and can be made as small single track gates to as large as box frames.

Box Frame Gates Available
Built to Your Custom Specifications

Available with:

- Slats
- Barbwire
- Special Wire
- Color Wire
- Powder Coated



Privacy Panels & Gates

Metal Privacy Panels

Built from the Aberdeen two rail platform, this product provides privacy with an industrial level of quality. An 11 gauge steel channel is used to house 25 gauge interlocking galvanized boards. A polyester resin powder-coated finish crates an aesthetically pleasing, corrosion resistant and virtually maintenance free visual barrier. Swing gates and slide gates are also available.

Great for:

- Hotels
- Junk Yards
- Service Stations
- Restaurants
- Shopping Centers
- Military Bases
- Dumpster Enclosures
- Schools
- Amusement Parks
- Condominiums
- Equipment Enclosures
- Noise Barrier



Privacy Panels/Dumpster Enclosures Features



Powder Coated
(All Colors Available)

Optional Angle Board for Added Privacy

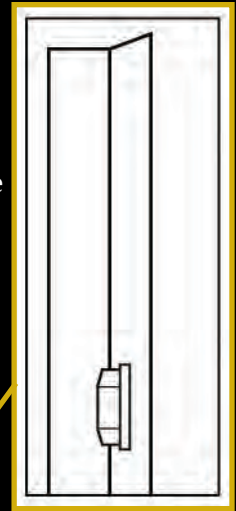

Embossed Wood Grain Finish

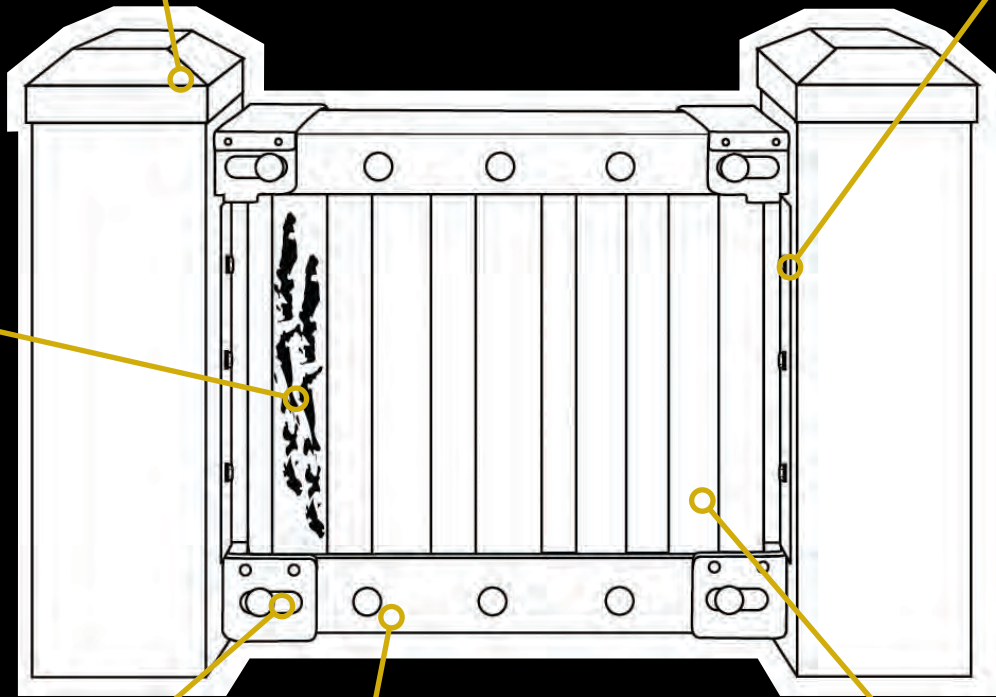

G90 Galvanized Steel Interlocking Boards; 25 Gauge
(Top View)

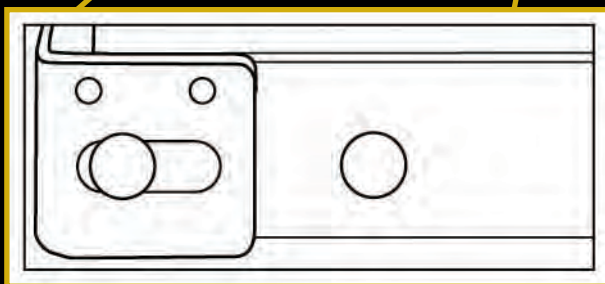

11 Gauge G90 Galvanized Steel Channel

Industrial Aircraft Rivets for Added Durability and Strength

Polyester Coated Pipe

Post Size	2 inch	2½ inch	3 inch	4 inch	6 inch	8 inch
Gauge(s)	14 & 16 g	14 & 16 g	12 g	11 g	3/16" wall	1/4" wall

Available Hardware

Swing Gate Hardware

Self Closing Hinge	ILD Self Closing
4" Press Steel Hinge	Fulcrum latch 2.5 gav
Barrel Hinges	Fulcrum latch 3 gav
Pilaster Hinges	Fulcrum latch 4 gav
2.5" Black Hinge	Fulcrum latch 2.5 black
3" Black Hinge	Fulcrum latch 3 black
4" Black Hinge	Fulcrum latch 4 black
6" Black Hinge	4" Cantilever latch
Top Pull Latch	6 5/8" Cantilever latch

Ornamental Iron Accessories

- Swivel brackets
- Press steel bracket
- Press steel bracket w/o cover
- Self tapping bracket bolts
- 6x6 post plate
- 8x8 post plate

Slide Gate Hardware

4" Truck bracket	Blank channel
6 5/8" Truck bracket	2" sq. Gate stops
Truck assembly - 4 wheel	4" Lower guide
Truck assembly - 8 wheel	Lock box
Alum 2x2	Drop Rod
Splice kit	

Post Accessories

2" flat cap	2.5" ball cap
2.5" flat cap	3" ball cap
3" flat cap	4" ball cap
4" flat cap	6" ball cap
6" flat cap	
2" ball cap	

Custom

Whatever our customers need, Iron World® can deliver. No job is too small or too complicated for our highly skilled metal workers. In addition to our standard options such as rings and finials, Iron World™ builds custom products to satisfy all of our customers iron fencing requirements.

Panic Gates

Reverse Gates

Special Colors

Special Spacing

Panic Gate





IRON WORLD[®]

9390 Davis Avenue

Laurel MD 20723

Phone: 866-310-2747 Fax: (301) 776-7449

www.ironworldfencing.com